

Article number: 20279B48OZ2BL

Description: E+G Swivel clamp connector - GN 279-B48-OZ-2-BL

Measures

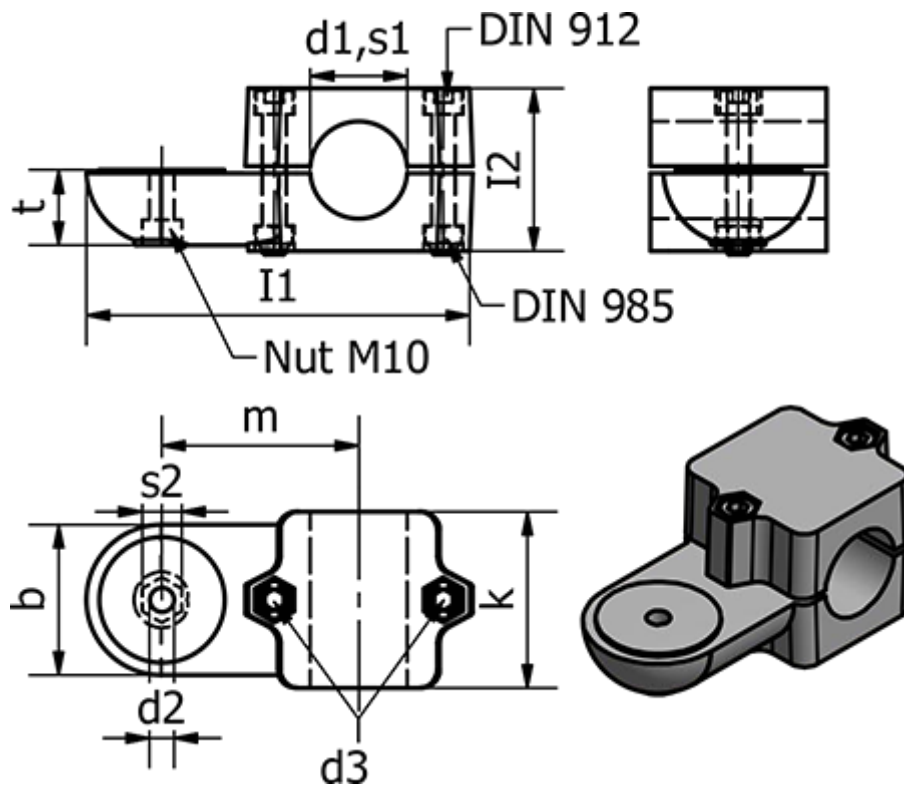

b	= 65	k	= 76
Clamping kit for d3	= -	m	= 85
d1	= B48	s1	= -
d2	= 10.5	s2	= 17
d3	= M10	t	= 35
d4	= M10	Weight (g)	= 790
I1	= 166.5		
I2	= 70		